



Our **company**

Our company Eko-Okna S.A. is an international manufacturer of PVC, wooden, aluminium, and steel windows and doors. We have been on the market since 1998. Production takes place in halls equipped with the most modern, fully automated factory lines. The production process is supported by a qualified and experienced workforce. We focus on development and innovation. As the first in Europe, we introduced windows made with V-Perfect profile welding technology to mass sales.

Our range is constantly expanding. Today, we can offer you dozens of different window and door systems. We also offer sliding systems, roller shutters, sectional garage and industrial doors, mosquito nets, fences, and pergolas. As an addition to windows and doors, we offer blinds. We manufacture internal and external blinds, facade blinds, and shutters. All of the highest quality, as we only use high-quality materials from leading European suppliers.

Years of experience allow us to accurately predict demand and respond to customer needs. A fresh look at changing trends allows us to create products that are a complete response to market needs. Multi-million investments in the machine park, experience, and multilingual staff contribute to the growth of our export strength year by year. We effectively expand into European and non-European markets.

The quality of our products and our actions have gained recognition from customers worldwide. So far, we have created a powerful sales network, which we constantly expand.



FACADE **BLINDS**

A classic solution providing an exceptionally tight barrier against sunlight due to the use of high-quality materials for its construction and the possibility of installation on the external side of the window. In an aesthetic way, they change the appearance of building facades, while their installation slows down heat exchange, allowing for a decrease in temperature inside the building by up to 9°C.



Overhead Facade Blinds

Overhead facade blinds are an optimal solution to the problem of excess light and heat in rooms. The wealth of available aesthetic solutions makes it easy to adapt the appropriate blinds to any building. They can be used when the construction project includes the installation of a box in the lintel. Our aluminium boxes can be used in many systems and are also very versatile.



BASIC



RAFF-I



RAFF-E



SKEF



Overhead Facade Blind **BASIC**

Basic is a versatile system of facade blinds. The system's versatility is ensured by the adjustment of the upper rail brackets and the adjustment of the guide brackets. This allows for easy installation in most homes - in adaptive and flush-mounted systems. The system's design enables the use of guides, which are installed using brackets and monolithic guides mounted directly to windows.

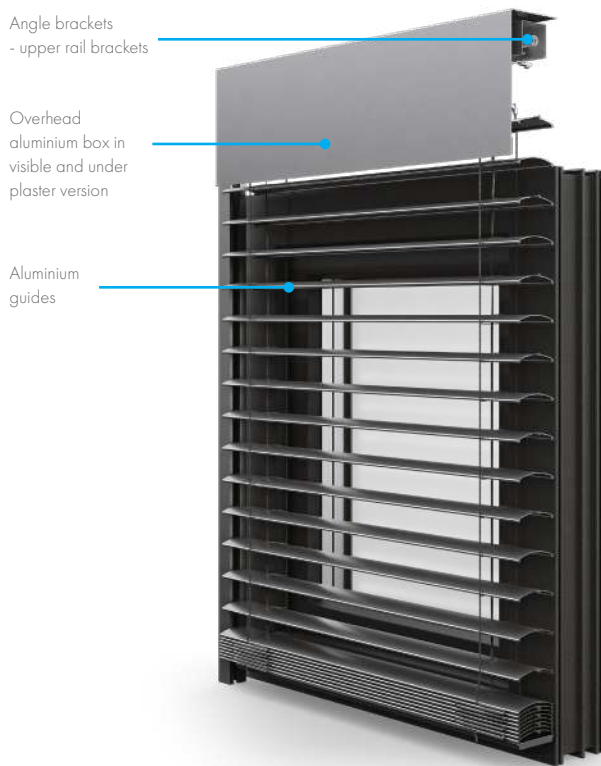

Lamel shapes:

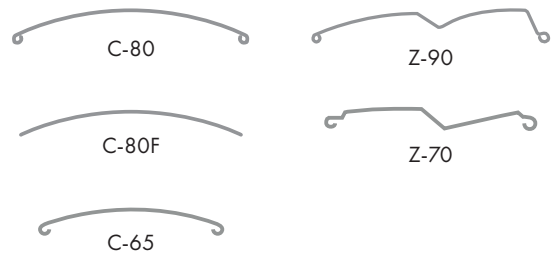

Blind cover shapes:

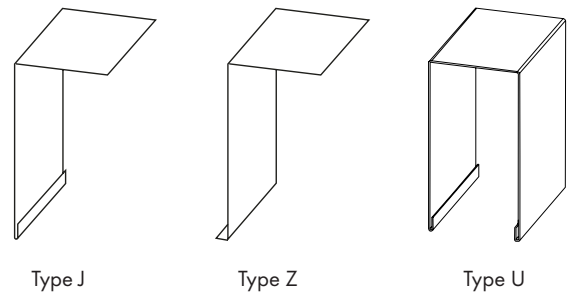

Box shape:
rectangular ALU



Maximum box width:
6000 mm

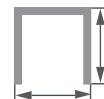

Box size:
200 x 140 mm
240 x 140 mm
300 x 140 mm
350 x 140 mm



Minimum box width:
550 mm

Overhead Facade Blind **RAFF-I**

RAFF-i is a modern system with an aluminium casing, which is mounted either onto the lintel or directly onto the facade. Special pins protrude from the casing, which simply need to be inserted into the previously mounted guides, making the installation of the entire system simple and very fast. The casing with its distinctive embossing, giving it a unique and modern appearance, is available in a visible or concealed version.

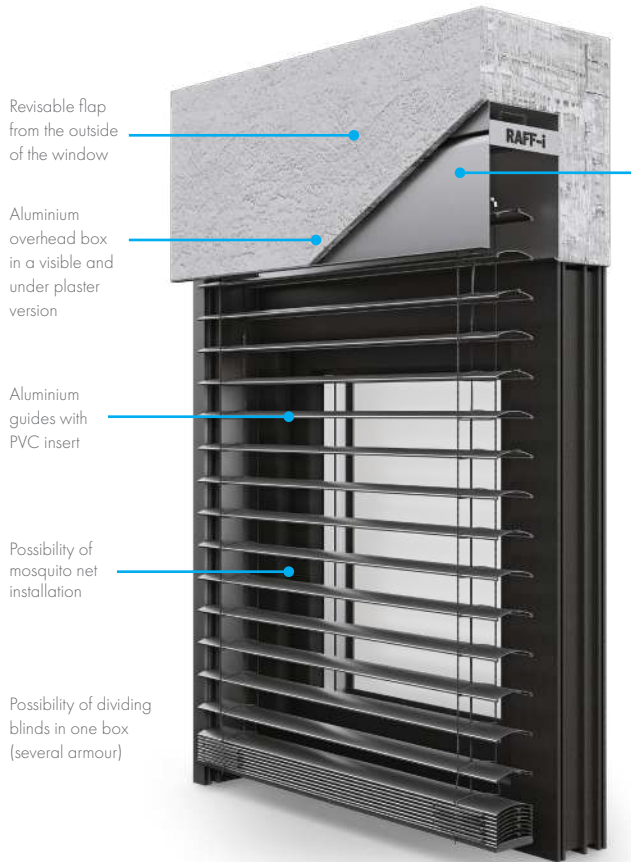

Reversible flap from the outside of the window

Aluminium overhead box in a visible and under plaster version

Aluminium guides with PVC insert

Possibility of mosquito net installation

Possibility of dividing blinds in one box (several armour)

Possibility of setting the box away from the window frame and insulating

Lamel shapes:

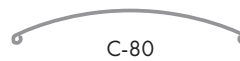

C-80

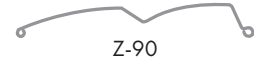

Z-90

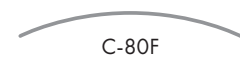

C-80F



Z-70

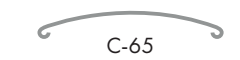

C-65



Box shape:
rectangular ALU



Maximum box width:
6000 mm



Box size:
200 x 140 mm
240 x 140 mm
300 x 140 mm
350 x 140 mm



Minimum box width:
560 mm

Overhead Facade Blind **RAFF-E**

The RAFF-e system is a product designed based on extensive technical knowledge, which makes the blinds easy to measure and their installation efficient and fast.

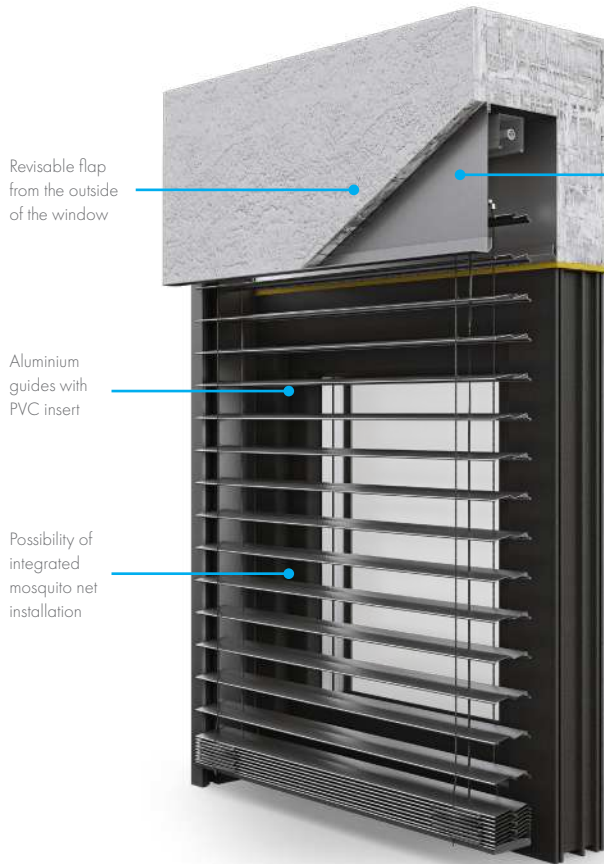

Reversible flap from the outside of the window

Aluminium overhead box in a visible and under plaster version

Aluminium guides with PVC insert

Possibility of integrated mosquito net installation

Label shapes:

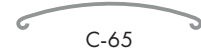
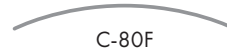
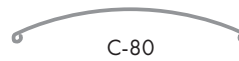

Box shape:
rectangular ALU



Maximum box width:
4000 mm

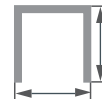

Box size:
200 x 140 mm
240 x 140 mm
300 x 140 mm



Minimum box width:
560 mm

Overhead Facade Blind **SKEF**

A system featuring a distinctive casing cut at a 45-degree angle from the outer side. An ideal solution for those who prefer finishing elements with sharp geometric shapes. The casing is designed for installation both directly on the facade of the building and in the window frame recess.

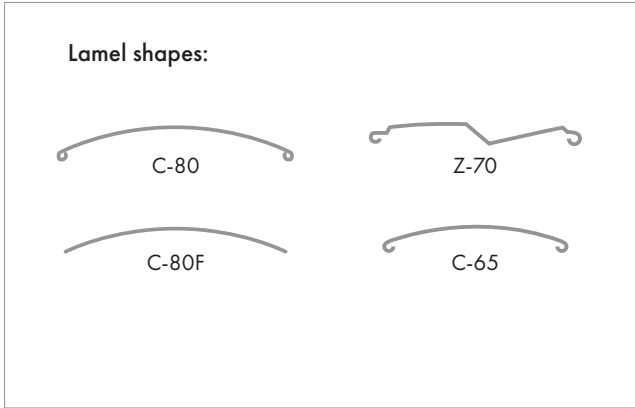
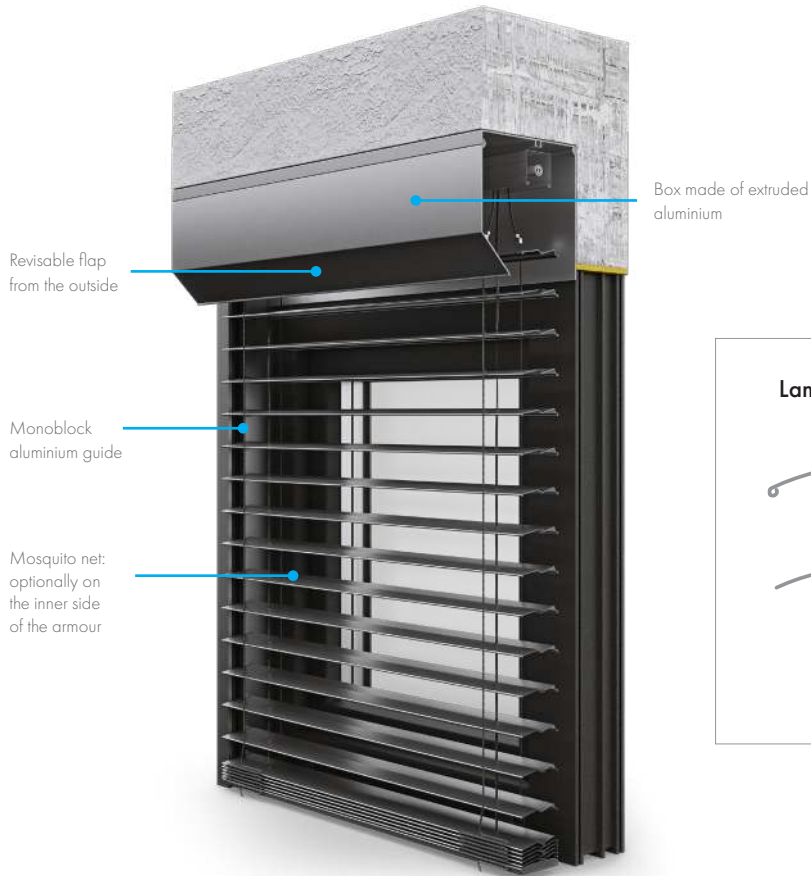

Box shape:
 rectangular ALU

Maximum box width:
 4500 mm

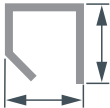
Box size:
 180 x 140 mm
 205 x 140 mm

Minimum box width:
 560 mm

Top-mounted **Facade Blinds**

Top-mounted facade blinds allow for the adjustment of light and temperature inside a room without the need for complete window blackout. They are available in various configurations, including an option with Z-shaped slats that provide total blackout when necessary. They can be controlled manually, via a radio remote control, or through an integrated Smart Home system. Some models feature insulation in the construction or are built with insulating materials.



ELITE XT



CLEVERBOX



ROKA TOP 2 SHADOW



SKB



Top-mounted Facade Blind **ELITE XT**

The system's design enables better thermal and acoustic insulation. It saves a significant amount of thermal energy, especially during cooler times of the year. The system is well-known in Western markets, being the only one to offer PVC guides in color or with veneer in the All-in-one system.

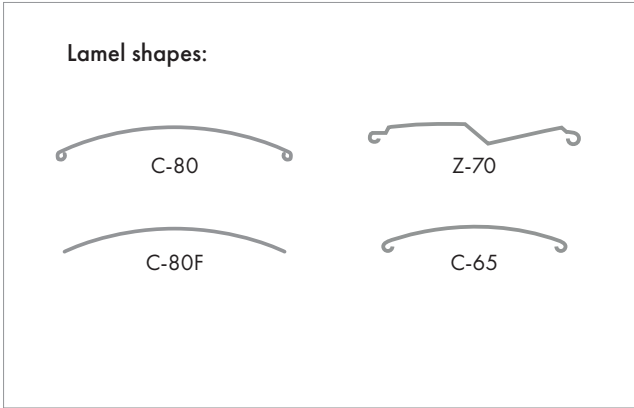
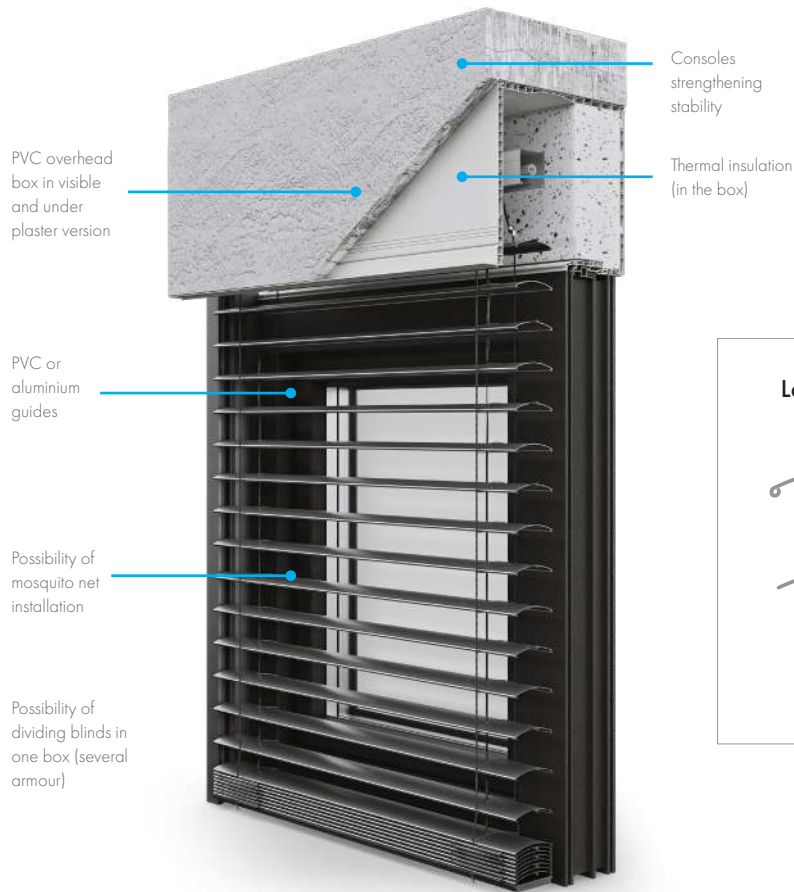

Box shape:
 rectangular ALU



Maximum box width:
 4500 mm

Box size:
 240 x 255 mm

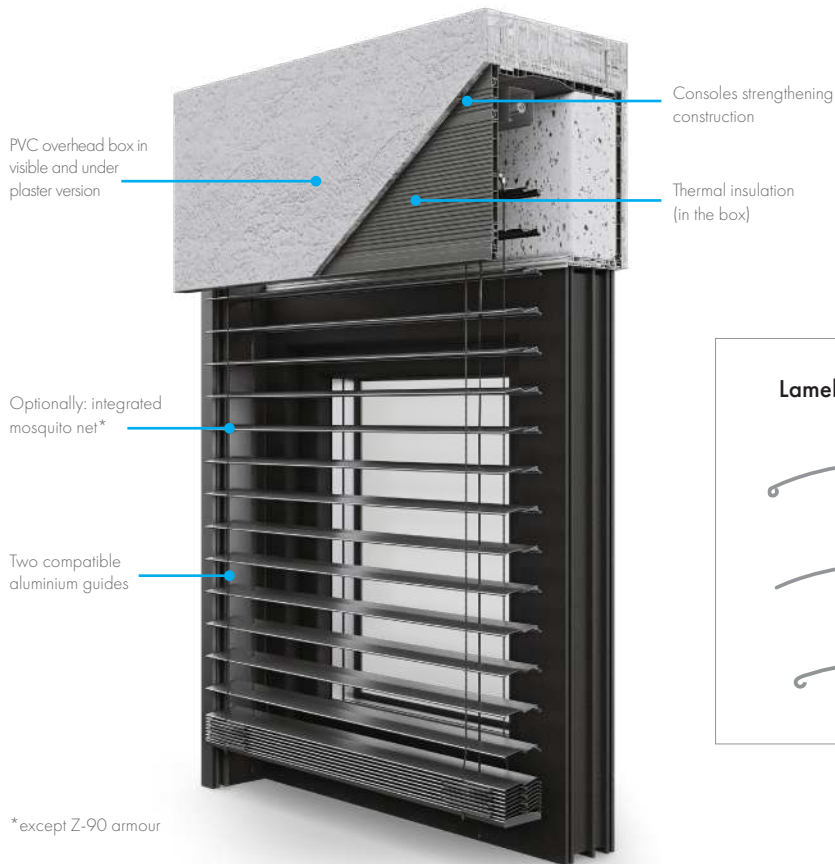

Minimum box width:
 630 mm

Top-mounted Facade Blind **CLEVERBOX**

The system stands out for its best thermal and acoustic insulation parameters, thanks to its unique structure and very high quality of the components used. It is the only overhead system that allows for the use of Z-90 facade blinds, guaranteeing full room darkening. It ensures comfort for users both in summer and winter.

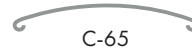
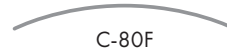
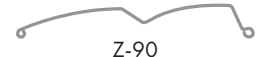

Lamel shapes:



Box shape:
rectangular ALU



Maximum box width:
4500 mm



Box size:
245x 255 mm



Minimum box width:
560 mm

Top-mounted Facade Blind **ROKA TOP 2 SHADOW**

The combination of Neopor®/Styropor® material with a tight construction results in excellent parameters in terms of protection against sunlight, wind, and moisture. Reinforced along its entire length using embedded steel mesh and additional reinforcements (mounted in stabilizing foam brackets), a construction is created permanently attached to the window and wall. It can be seamlessly integrated with any type of finishing (plaster, External Wall Insulation Systems (EWIS), clinker), creating a cohesive unit with the wall.

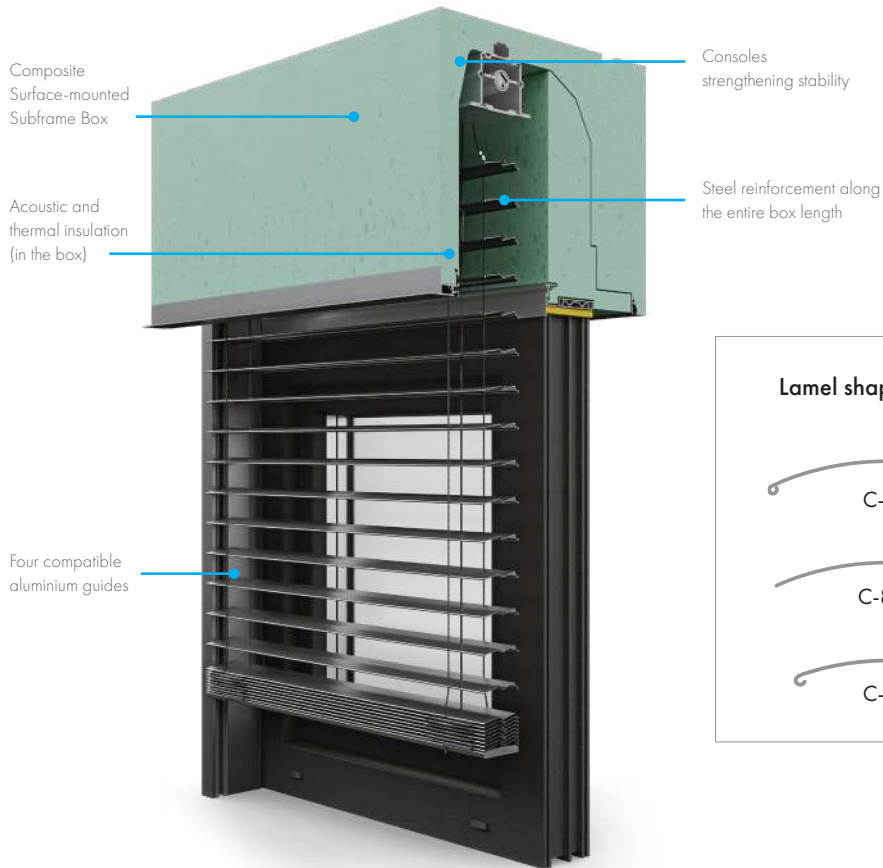

Lamel shapes:

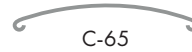
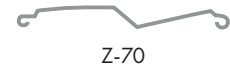
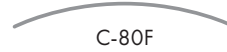
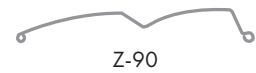
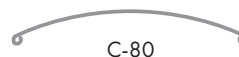

Box shape:
rectangular
Neopor®/Styropor®



Maximum box width:
6000 mm



Box size:
300 x 280 mm
300 x 300 mm
300 x 345 mm
300 x 365 mm



Minimum box width:
580 mm

Soffit Facade Blind **SKB**

The system was primarily created to improve the energy balance of the building. The main component of the system is a box, which is made of high-quality insulation material - styrofoam, which has very good thermal properties.

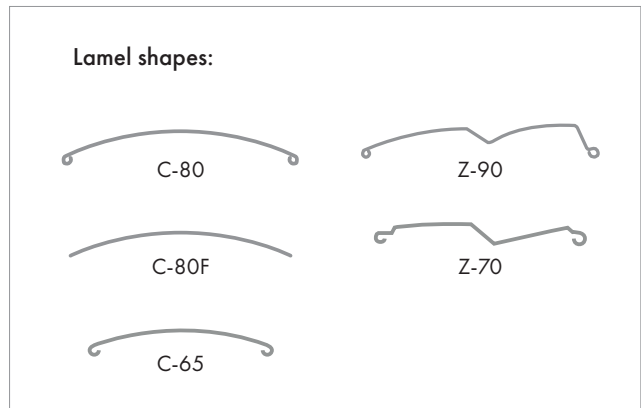
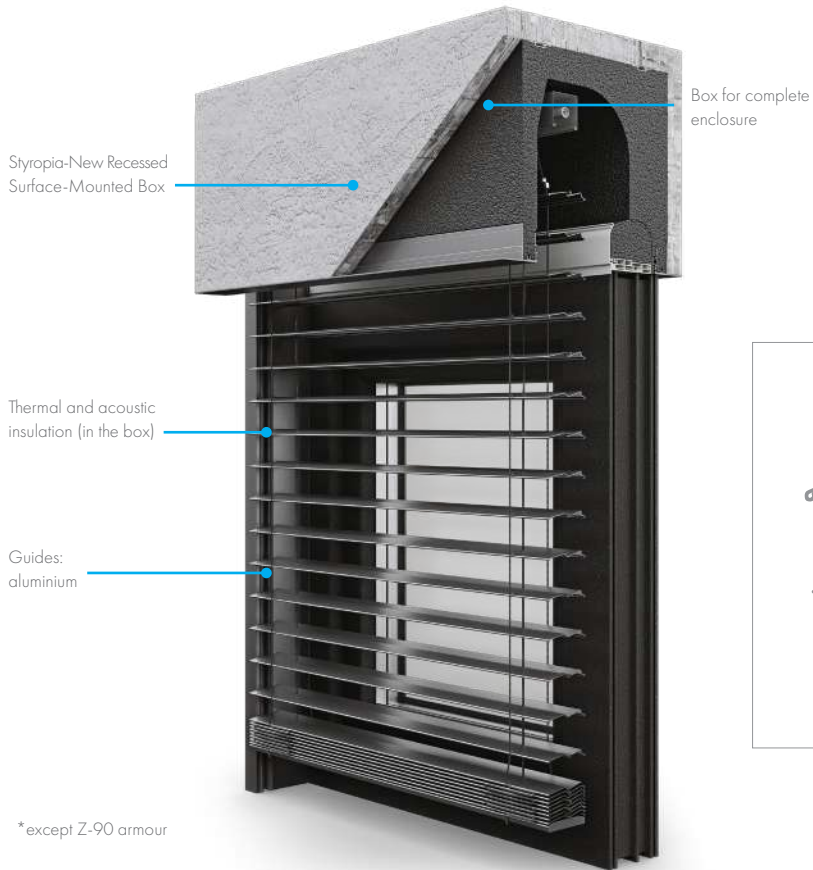

Box shape:
 rectangular styrofoam

Maximum box width:
 3600 mm

Box size:
 260 x 263,6 mm
 305 x 310,6 mm

Minimum box width:
 630 mm

Shapes of lamellas

The choice of shape and size of lamel is a decision related to both the aesthetics and functionality of the solution. This allows for various degrees of interior darkening, as well as adjusting the height of the package after folding.



C-80

The C-80 profile allows for the bidirectional rotation of lamel. Constructions based on this type of lamels let in a small amount of light even when closed. They are an optimal solution for those wanting to effectively control the flow of light with the changing position of the sun in the sky.



C-80 Flat

The C-80 Flat lamel profile is characterised by the lowest package height after folding - rolling up the blinds. Therefore, it is an optimal solution when there is limited space for installing high boxes. The rotation angle of C-80 Flat slats is 90 degrees.



Z-90

The distinguishing feature of Z-90 profiles is the ability to achieve complete darkening in interior spaces protected by them. This is enabled by their special shape and the presence of sealing, which also reduces the noise produced by lamels moving due to strong gusts of wind.



Z-70

Z-70 is a more pronounced version of the popular Z-90 solution. This slat shape retains all the most important advantages of the Z slat, including, and most importantly, its ability to achieve complete darkening of the interior. Choosing the Z-70 slat gives the option of selecting a box with a smaller depth compared to the Z-90 option.



C-65

C-65 lamellas are one of the most popular products on the market. Their classic shape is consistently valued by customers. The rolled edges improve their static parameters, allowing them to be used on larger glazed areas.





The colour of the **lamellas**

Guides, bottom rails, and blinds boxes can be painted in any colour from the RAL palette, e.g., to perfectly match the colour of the windows ordered by the customer. However, there is no possibility of such precise colour matching in the case of the slats themselves. They are produced from aluminium strips, which are already coated with paint. During the production of finished slats placed in blinds, they undergo an additional process of applying and curing subsequent layers of paint and clear protective varnishes, which give the product its final shine.

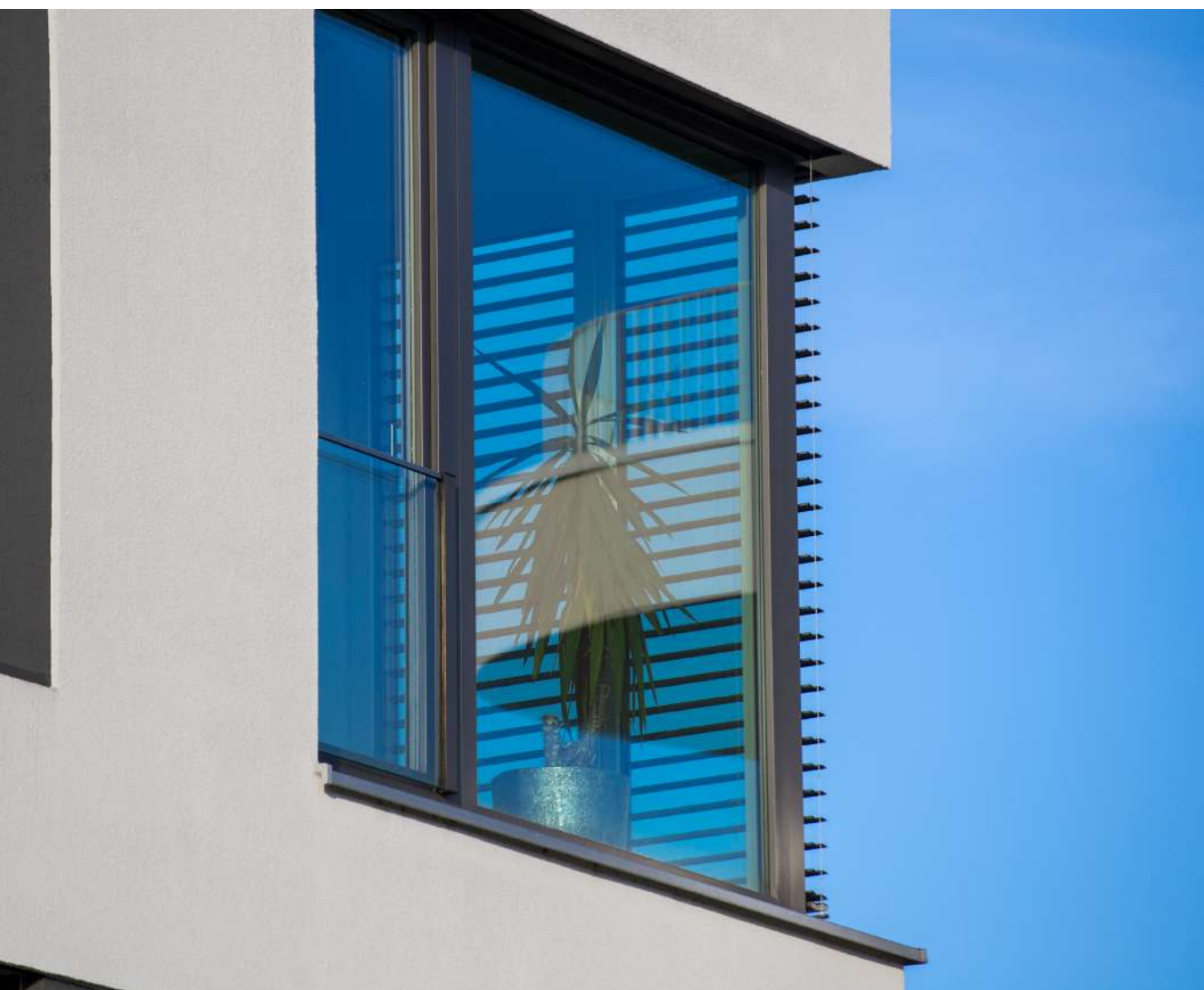

C-80

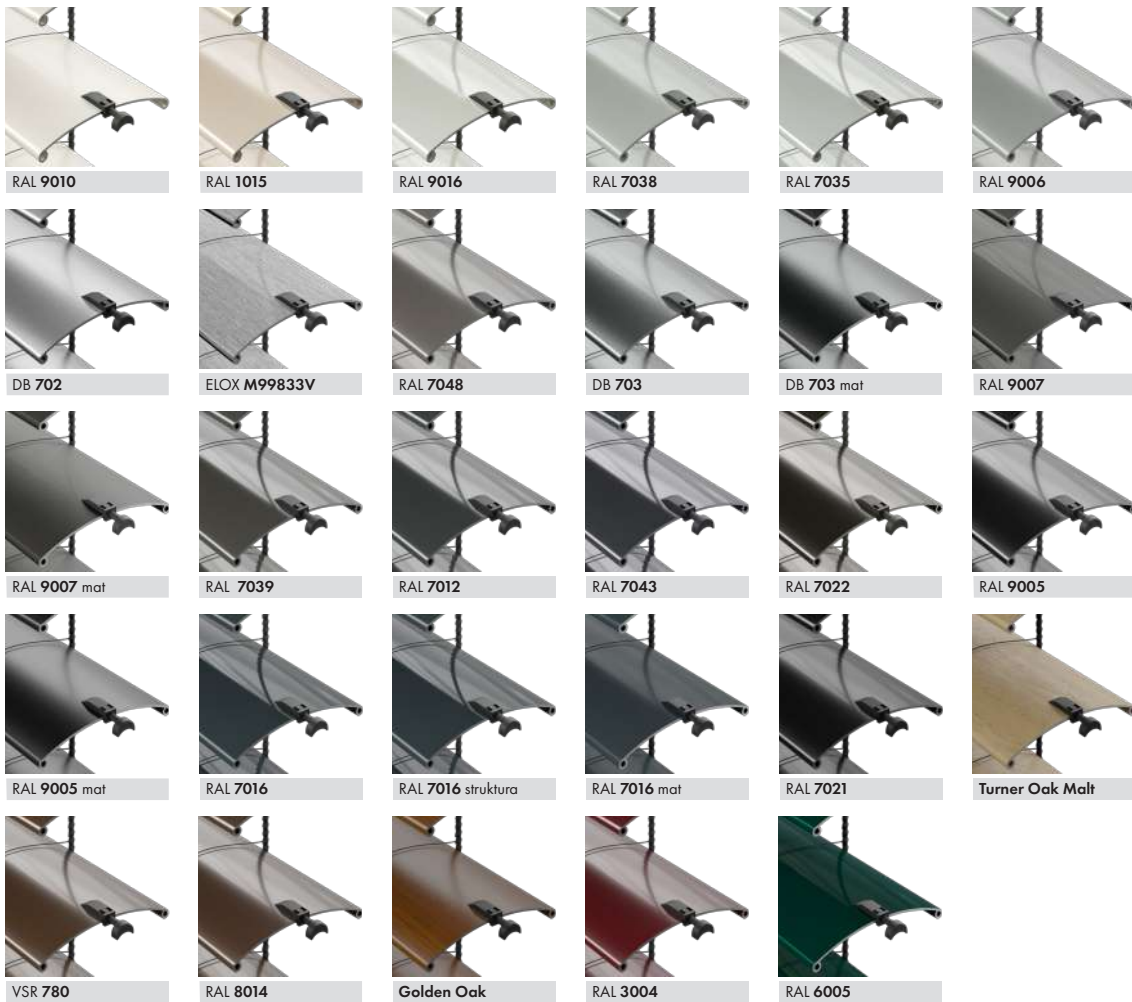

C-80F



C-65

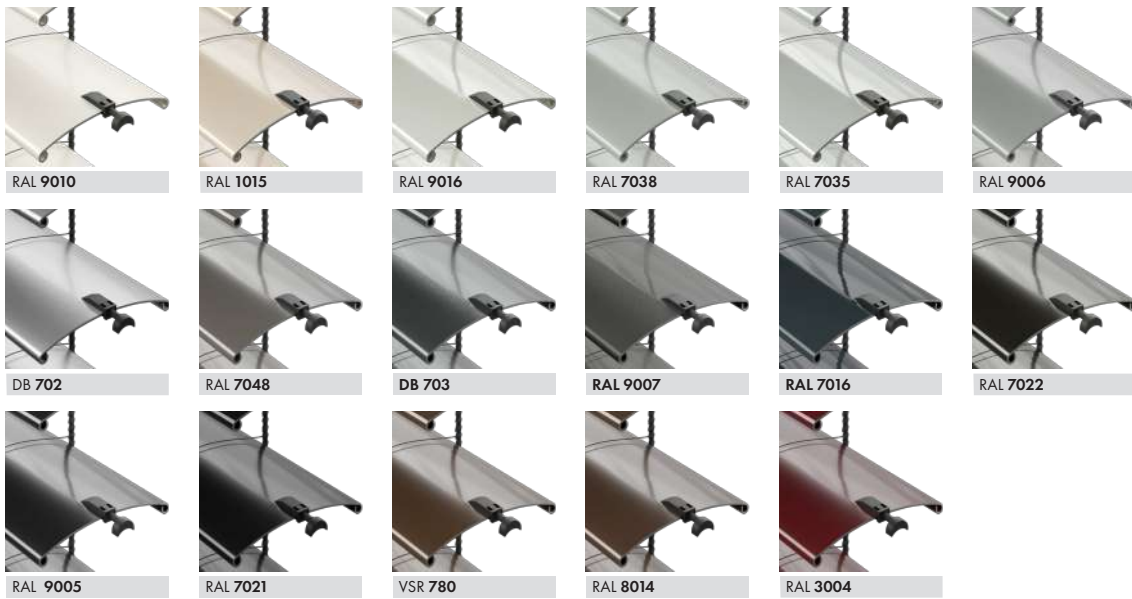

Z-70

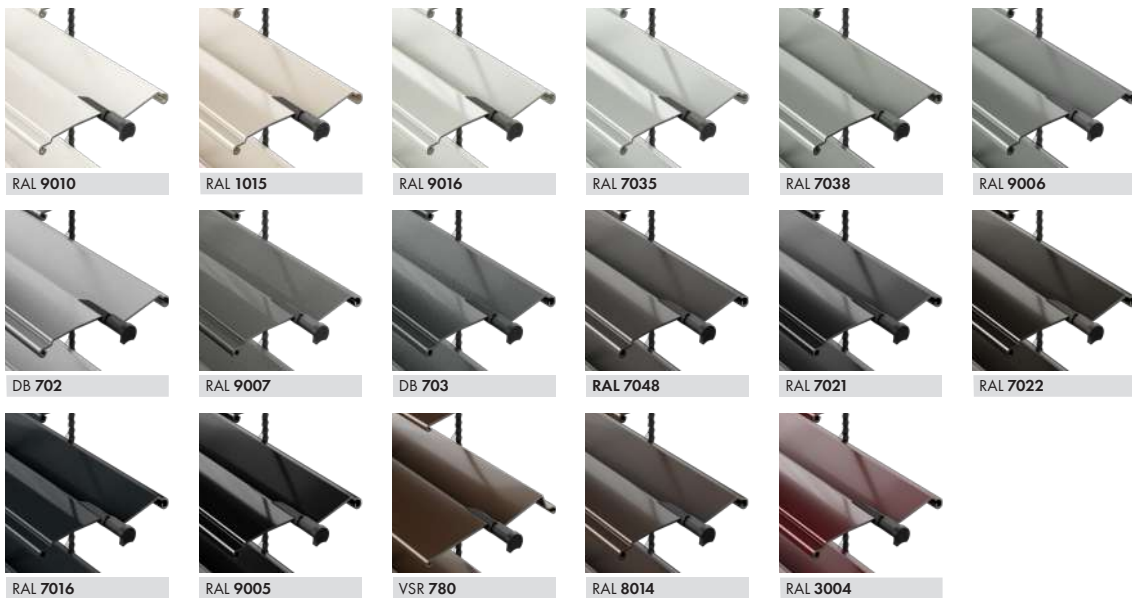

Z-90



RAL 9010



RAL 1015



RAL 9016



RAL 7035



RAL 7038



RAL 9006



DB 702

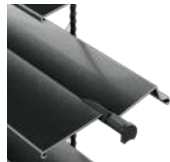

DB 703



DB 703 mat



RAL 9007



RAL 7048



RAL 7022



RAL 7021



RAL 9017



RAL 9005



RAL 9005 mat



RAL 7016



RAL 7016 mat



Turner Oak Malt



YSR 780



RAL 8014



RAL 3004



RAL 6005



RAL 7012



RAL 7039



Golden Oak

Guides

The guides of facade blinds are made of aluminium painted in colours from the RAL palette or PVC. They provide stability to the blind's armour. In All-in-One solutions, their aesthetics are matched to the other products included in the package.

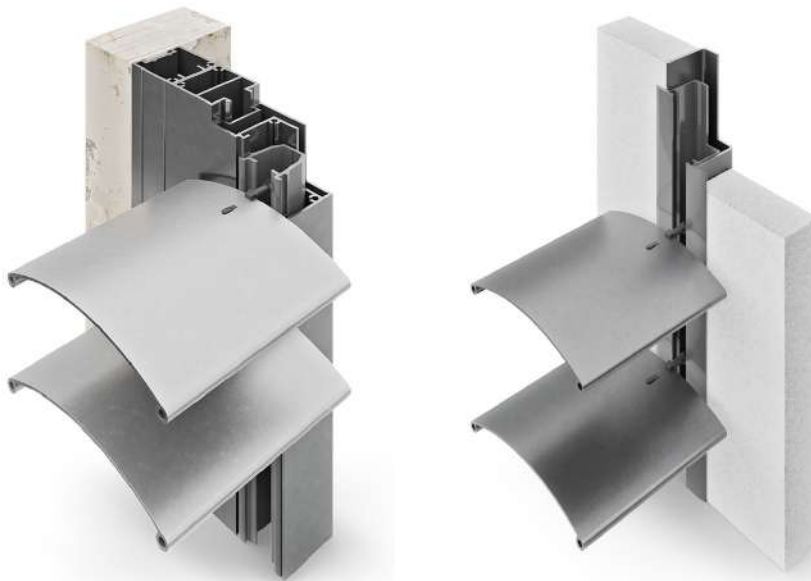

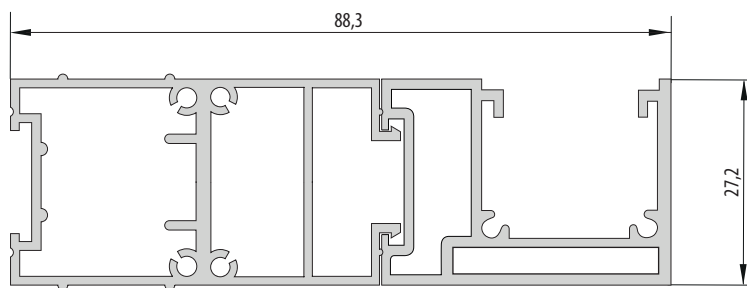

SOLID monoblock guide
RAFF-e
Basic
Roka Top 2 Shadow
RAFF-i

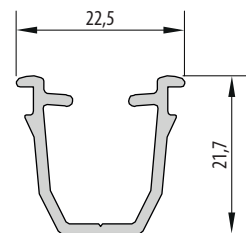

A40
RAFF-e
Basic
Roka Top 2 Shadow
RAFF-i

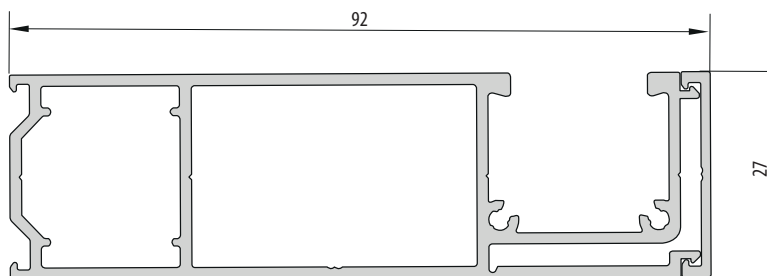

Eko-Okna monoblock guide
RAFF-e
Basic
Roka Top 2 Shadow
RAFF-i

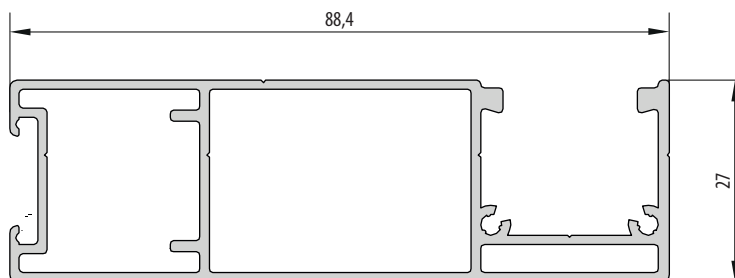

A45
RAFF-e
Basic
Roka Top 2 Shadow
RAFF-i

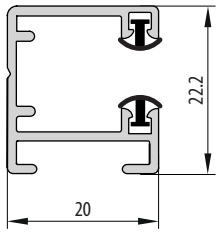

Type 2
Basic
Roka Top 2 Shadow
CleverBox

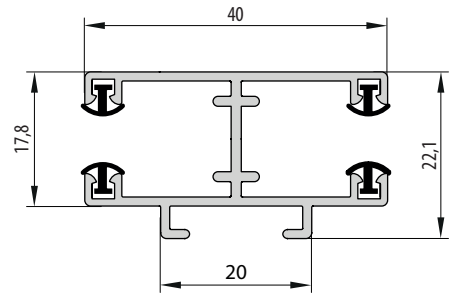

Type 4
Basic
Roka Top 2 Shadow
CleverBox

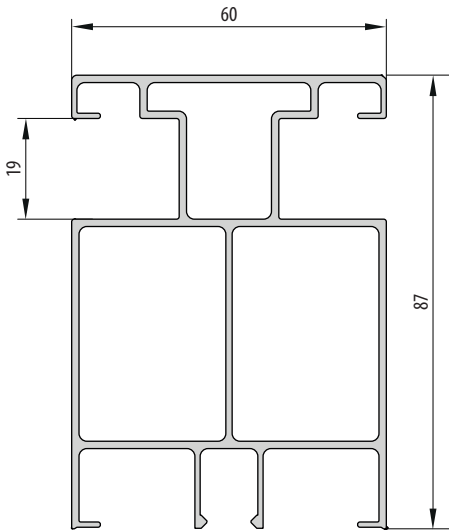

PG10
CleverBox

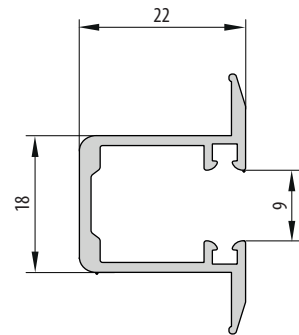

PG12
CleverBox

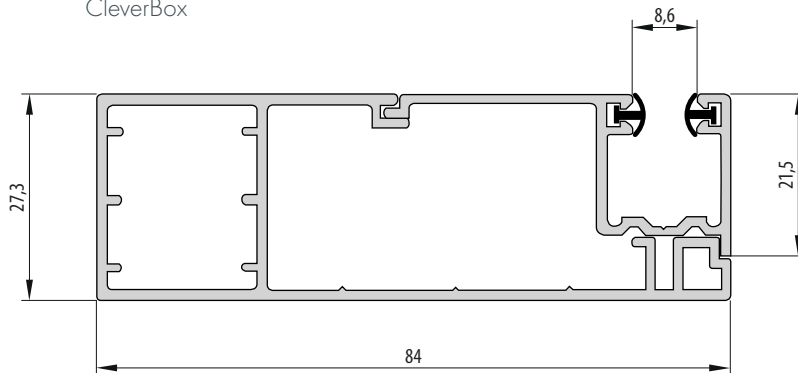

APPF - PPF
SKEF

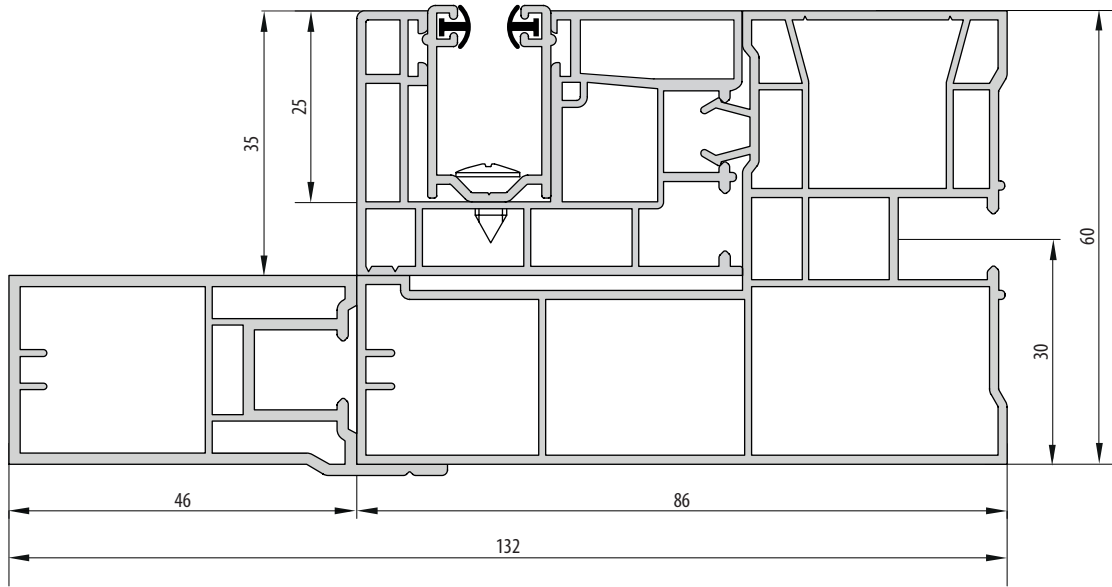

5080 - 5081
Elite XT

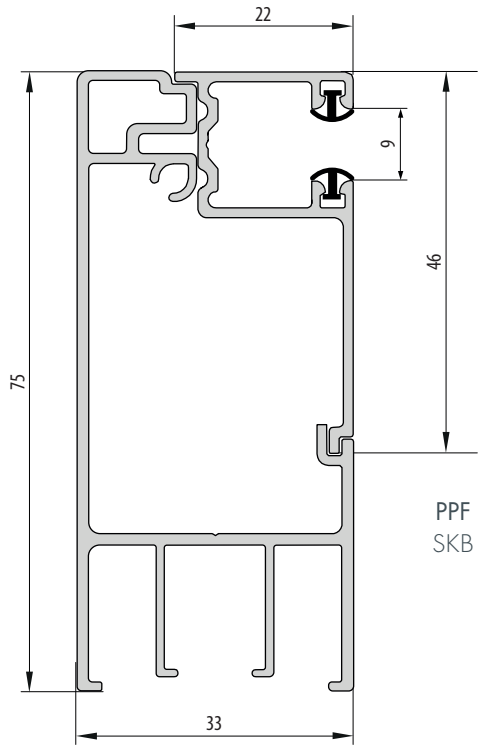

APPF-B_33
SKB

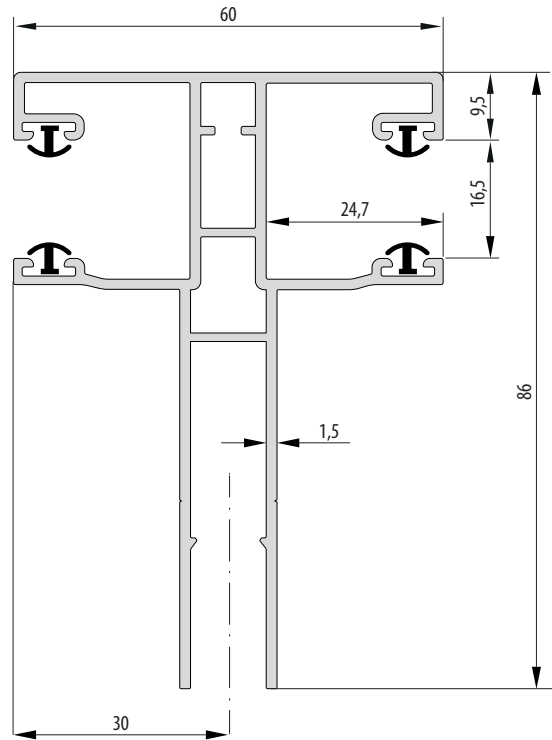

EX 5434
Elite XT

Accessories and **Automation**

Facade blinds reach their full potential only after selecting the appropriate accessories and automation. Available options are related to ensuring their safety, smooth regulation, or autonomous operation in response to weather conditions.

Modern control mechanisms, in turn, allow precise control of the blinds, creating scenarios, and managing window coverings from anywhere in the world.

The offer includes all leading brands, especially prestigious Somfy, reliable Geiger, and universal Elero.

The full range of automation for facade blinds is available from sales representatives and on the Eko-Okna website.

CONTROL **SENSORS**



REMOTE **CONTROLS**





benefit Eko-Okna is a free, industry-specific compendium of knowledge about joinery.

It contains everything that is needed in the daily work of a distributor:



- product tutorial
- technical catalogue
- garage doors calculator
- assembly instructions
- materials from suppliers



Scan
the code

benefit.ekookna.com



eko **4u**

eko4u is a tool for distributors in the joinery industry. eko4u represents a new dimension in managing your business. With it, you can:



- create offers and orders independently
- control deliveries
- browse and download invoices
- submit complaints



Scan
the code

eko4u.com